



**OWNER'S MANUAL**

**DASH 500W E-BIKE**



[www.serfas.com](http://www.serfas.com)

# **SERFAS DASH 500W**

## **OWNER'S MANUAL**

Thank you for purchasing a Serfas Dash 500W e-bike!  
Before riding, please take a moment to review these instructions.

Need service or support? Visit our website for quick answers, manuals, and/or give us a call and we'll find you a solution.

### Dash 500W **Step-Through Frame**



# CONTENTS

Using this manual/General Safety	4
Bicycle specifications	7
Battery charging	8
Display and controls	9
Operation guide	10
Riding menu	11
Error codes	12
User menu	13
Walk Assist	18
Factory reset	19
Maintenance and service	20
Storing your bike	20
Warranty policy	21

Serfas, Inc  
2333 W Utopia Rd  
Phoenix, AZ 85027  
Phone: 1-(800) 424-0047  
Email: [info@serfas.com](mailto:info@serfas.com)

---

# USING THIS MANUAL

This manual contains details, information, provides tips and instructions for basic operation, warranty, and battery safety. This manual may contain warnings, and cautions concerning the safe operation and use of your new bicycle.

All information in this manual should be received and followed carefully, should you have any questions please contact Serfas immediately.

Serfas bicycles are only sold in authorized bicycle dealers and all assembly, and maintenance procedures should be completed by an authorized retailer, or certified bicycle mechanic.

This bike has been tested and passed to the UL-2849 standard. Any unauthorized modifications, and/or use of non Serfas supplied e-bike system components will result in voiding of warranty, compliance to UL-2849, and create an unsafe riding condition, damage to property, or result in serious injury or death.

## GENERAL SAFETY

### **INSTRUCTIONS PERTAINING TO RISK OF FIRE or ELECTRIC SHOCK**

#### **IMPORTANT SAFETY INSTRUCTIONS**

**WARNING! When using this product, basic precautions should always be followed, including the following:**

- a) Read all the instructions before using the product.
- b) To reduce the risk of injury, close supervision is necessary when the product is used near children.
- c) Do not put fingers or hands into the product.
- d) Do not use this product if the flexible power cord or output cable is frayed, has broken insulation, or any other signs of damage.
- e) This equipment is not intended to be used at ambient temperatures less than  $-4^{\circ}\text{F}$  ( $-20^{\circ}\text{C}$ ) or above ambient temperatures of  $113^{\circ}\text{F}$  ( $45^{\circ}\text{C}$ ).
- f) The battery is intended to be charged when the ambient temperature is between  $32^{\circ}\text{F}$  ( $0^{\circ}\text{C}$ ) and  $104^{\circ}\text{F}$  ( $40^{\circ}\text{C}$ ). Never charge the battery when ambient temperatures are outside this range."

**WARNING! It is your responsibility to comply with all traffic related laws and to use proper equipment. This includes appropriate cycling attire and bike maintenance.**

Observe all local bicycle traffic laws and regulations.

Observe regulations about bicycle lighting, licensing riding on pavements/sidewalks, bike path and trail use, helmet laws, child laws relating to cycling, and special bicycle traffic laws, it is your responsibility to know and obey your local laws.

- When riding a bike, always wear a properly fitted helmet that covers the forehead. Many locations require specific safety devices. It is your responsibility to familiarize yourself with the local laws, rules, and regulations where you ride and to comply with all applicable laws, including equipping yourself and your bike as the law requires.
- Unless otherwise stated, a rider's weight and luggage should not exceed 300lbs/136kg.
- Before you ride your bike, always check to make sure everything is working properly and correctly aligned.
- Be familiar with the controls of your bicycle, such as brakes, pedals and shifting etc..
- Keep all body parts or any obtrusive objects away from the sharp chainrings when pedaling. Failure to wear proper attire could lead to injuries.
- While riding, remember you are sharing the road or path with others. i.e. motorists, pedestrians and other cyclists.

- Always be a defensive rider. Always assume that others do not see you and expect the unexpected
- Always be aware of your surroundings. Be alert and responsive to:
  - 1) Motor vehicles of all types and in all directions.
  - 2) Unexpected movement of obstacles.
  - 3) Nearby pedestrians.
  - 4) Children or animals in the area.
  - 5) Imperfections of bike paths or paved roads including potholes, uneven surfaces, loose gravel construction and debris.
  - 6) Warning, hazard and yield signs.
- Ride in designated bike lanes when available and always ride in the direction of traffic.
- Acknowledge and stop at ALL stop signs and traffic lights.
- When coming to a complete stop, look both ways at street intersections before continuing onward.
- Use hand signals for turning and stopping.
- Do not ride with headphones.
- Never hold onto another vehicle.
- Do not weave through traffic or make unexpected moves or turns.
- Rules that govern the right-of-way for motorists apply to cyclists. A bicyclist should always be prepared to yield
- Do not ride while under the influence of alcohol or drugs.
- Avoid riding in bad weather when visibility is obscured, for examples dawn, dusk, or in the dark such conditions increase the risk of accident.

### **Wet Weather**

***It is recommended to not ride in wet weather if avoidable. Ride in wet weather only if necessary.***

Electric bikes are not meant for use in the heavy rain, or streams. Never immerse or submerge this product in water or liquid as the electrical system may be damaged.

- In wet weather you need to take extra care when operating this bike.
- Decrease riding speed to help you control the bike in slippery conditions.
- Brake earlier since it will take longer to slow down and come to a stop than when operated in a dry condition.
- Take care to be more visible to others on the road. wear reflective clothing and use approved safety lights.
- Road hazards are more difficult to see when wet; proceed with caution.

### **NIGHT RIDING**

Cyclists should exercise extra caution when riding at night. Bicyclists are very difficult for motorists and pedestrians to see in the dark and in many cases, night riding can be more dangerous than day riding.

Individuals of an appropriate age who are aware of the increased risks should take extra care when riding at dawn, dusk or at night. Please note that it is important to choose suitable apparel and specialized equipment when riding in unfavourable conditions to reduce the risk of injury.

**Warning!** Reflectors should not be used as substitute for required lighting. Cyclists are near to invisible for other cyclists and motorists if the necessary lights and reflective gear are not used. If you ride at night, take all required precautions to make yourself visible through the use of lights and reflectors. Lack of adequate lighting measures may result in serious injury or death. As a moving cyclist, reflectors are designed to reflect off of car and street lights to help you become more visible and recognizable when riding.

**Caution!** Reflectors and their mounting brackets should be checked regularly to ensure they are clean, straight and securely mounted. Check to be sure you comply with all local laws about night riding. The followings are recommended.

- It is important you take steps to enhance your visibility by wearing light-colored, reflective clothing and accessories. There are plenty of proper reflective gear options that can be worn : Vests, armbands, leg bands, stripes on your helmet, and blinker attached to your body and or bicycle.
- Make sure your clothing or miscellaneous items do not obstruct the visibility of your reflectors and lights.
- Make sure that your bicycle is equipped with reflectors for riding at dawn, dusk or at night
- Always ride slowly when riding at night.

## **Mandatory Equipment and Use Locations**

Before riding, ensure you have all required and recommended safety equipment and are following all laws pertaining to use an electric bike in your region. For example, these laws may specify the need for mandatory equipment, use of hand signals, and where you can ride.

## **Changing Components or Attaching Accessories**

The use of non-original components or spare parts can jeopardize the safety of your ebike, void your warranty and, in some cases, cause your ebike to not conform with laws pertaining to your bike.

## **Safety Check Before Each Ride**

Always check the condition of your bike before you ride in addition to having regular maintenance performed. If you are unsure of how to conduct a complete check of the condition of your bike before every ride, you should consult a certified, reputable bike mechanic for assistance.

## **Brakes**

Ensure that the brakes and their system components are free from damage, properly secured and working correctly. When fully squeezed, both front and rear brake levers should not be touching the handlebar. Take your bike to a certified, reputable bike mechanic to have the brakes repaired if you find a problem.

## **Battery Charged, Secured, and Unplugged**

Ensure the battery is adequately charged and operating properly. Ensure the battery charger is unplugged from the outlet, battery, then stored in a safe location before you ride. The battery **MUST** be locked onto the frame battery mount properly before use. Do not operate the electrical system if the battery is removed. Make sure push hard enough while installing the battery into the frame, and hear the "CLICK" sound.

## **CHARGER SAFETY INFORMATION**

- The charger should only be used indoors in a cool, dry, ventilated area, on a flat, stable, hard surface.
- Avoid charger contact with liquids, dirt, debris, or metal objects. **DO NOT** cover the charger while in use.
- Store and use the charger in a safe place away from children.
- Fully charging the battery before each use can help extend the life of the battery and reduces the chance of over-discharging.
- **DO NOT** charge the battery with any chargers other than the one originally supplied by Serfas Bikes or a charger designed for use with your specific bike purchased directly from Serfas Bikes.
- The charger works on 110/240V 50/60 Hz standard home AC power outlets and automatically detects and accounts for incoming voltage. **DO NOT** open the charger or modify voltage input.
- **DO NOT** yank or pull on the cables of the charger. When unplugging carefully remove both the AC and DC cables by pulling on the plastic plugs directly, and not on the cables.
- The charger is expected to get relatively warmer as it charged. If the charger gets too hot to touch, you notice a strange smell, or any other indicator of overheating, discontinue using the charger and contact Aventon Support.



Charge the battery only with the charger originally supplied with the bike from Serfas Bikes, or a charger purchased directly from Serfas Bikes, designed for use with your specific bike serial number, as approved by Serfas Bikes. Never use an aftermarket charger, which can result in damage, serious injury, or death.



Please take special care in charging your bike from Serfas Bikes in accordance with the procedures and safety information detailed in this manual. Failure to follow proper charging procedures can result in damage to your bike, the charger, or personal property, and/or cause serious injury or death.

### **General Warnings**

Like any sport, bicycling involves risk of damage, injury, and death. By choosing to ride a bike, you assume the responsibility for that risk, so you need to know, and practice the rules of safe and responsible riding and the proper use and maintenance of this bike. Proper use and maintenance of your bike reduces risk of damage, injury, and death.

Biking and controlled substances do not mix. Never operate a bike while under the influence of alcohol, drugs, or any substance or condition that could impair motor functions, judgement, or the ability to safely operate a bike or another vehicle.

The Dash 500W is designed for use by persons 18 years old and older. Riders must have the physical condition, reaction time, and mental capacity to ride safely and manage traffic, road conditions, and sudden situations, as well as respect the laws governing electric bike use where they ride, regardless of age. If you have an impairment or disability such as a visual impairment, hearing impairment, physical impairment, cognitive/language impairment, a seizure disorder, or any other physical condition that could impact your ability to safely operate a vehicle, consult your physician before riding any bike.

### **A Note for Parents and Guardians**

As a parent or guardian, you are responsible for the activities and safety of your child. Dash 500 is not designed for use by children under the age of 18. If you are carrying a passenger in a child safety seat, they should also be wearing a properly fitted and approved helmet.

Caution! Serfas is not reliable for accidents, injuries or product malfunctions that result from any unauthorized changes, modifications or tampering with any part of original specifications.

## **BICYCLE SPECIFICATIONS**

- Battery Capacity: 48v (13.6ah/636wh)
- Max Load Capacity: 300lbs / 136kg
- Motor: 48v 500w constant / 750w peak Brushless Hub Drive
- Water/ Dust Resistance: IPX4
- Bike Weight: 65lbs / 29.6kg
- Bike Class: 3
- Tire Size: 27.5 x 2.2
- Operating Temperature: -20° to 60°C / -4° - 140°F
- Charging Temperature: 0° to 45°C / 32°-113°F
- Charger Info: Max 54.6V DC 2.0A
- Max Range: Up to 60 miles (conditions, terrain, rider weight/load, and motor/throttle useage dependant)

# BATTERY CHARGING

The Dash 500W uses a Lithium-Ion battery which can be charged on or off the bike. We recommend charging the battery off the bike indoors, in moderate temperature conditions. To charge the battery, plug the charger into the charging port and then connect the charger to a wall outlet. The LED indicator light will be red when charging and will turn green when charging is complete. When finished, unplug the charger from the battery and from the wall outlet.

Take care of the battery to ensure a long service life.

- Charge and store the battery indoors if possible. The battery can be removed from the bicycle for this purpose.
- Avoid extreme hot and cold temperatures.
- DO NOT submerge your bike or any of the components in water. This action will void the warranty.

To optimize the performance of the battery over time, try and use it (discharging and charging) at least monthly. But if you won't be riding your Dash 500W for an extended period of time, it's best to store the battery fully charged. EVERY 2 MONTHS: Put battery on the charger to maintain optimum level.

After many charging and discharge cycles, runtime and range will be reduced. Replacement batteries are available from Serfas to extend the life of your e-bike. The lifespan of the battery is about 500 charge / discharge cycles for properly maintained batteries.

When you install the battery on the Dash 500W, it locks into place automatically. To unlock for removal, use the supplied key.

DO NOT ride the bicycle if the battery rattles or moves - it should be firmly attached.

## ***Throttle function***

This bike has been programmed for continuous use of the throttle above 2mph. Throttle will not work until bike is moving above the 2mph threshold. Once above threshold throttle will work with on demand.



# DISPLAY AND CONTROLS

## ■ Features Introduction

### ● Features & Parameter

Your Serfas display provides info about common riding data and statistical results, as well as partial practical features:

- ◆ Current Speed / Max. Speed / Avg. Speed
- ◆ Current motor power
- ◆ Battery level
- ◆ Assist level
- ◆ Total range / Trip range
- ◆ Trip time
- ◆ Calorie burnt
- ◆ Metric / British unit shifts
- ◆ Error code
- ◆ Auto headlight / Backlight adjusts / Auto backlight
- ◆ Auto power off time
- ◆ USB interface (5V/500mA)
- ◆ APP connection
- ◆ Mobile reminding
- ◆ Navigation Map
- ◆ Data synchronization
- ◆ Cycling Ranks
- ◆ Cycling track records

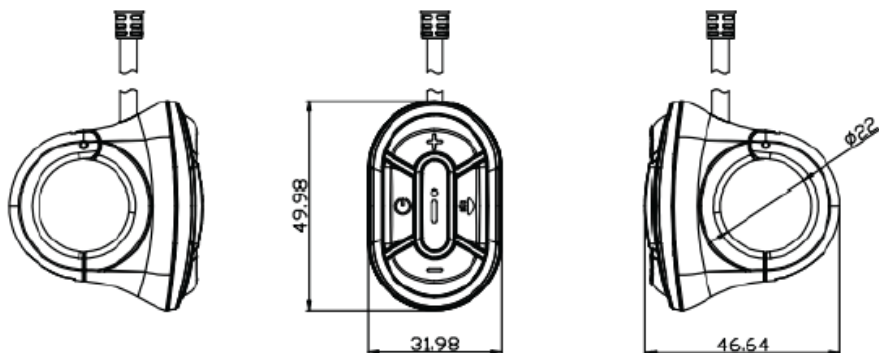

### ● Buttons

Button	Name	Function
	<b>【Power】</b>	1、 Power on/off 2、 Menu Operation
<b>+</b>	<b>【+】</b>	1、 Parameter Adjustment 2、 Menu Operation

—	【-】	1、Parameter adjustment 2、Push Assist starts/shutdown 3、Menu Operation
i	【i】	1、Parameter Adjustment 2、Menu Operation 3、Function Confirmation
☺	【Headlight】	1、Parameter Adjustment 2、Headlight Turns on/off 3、Menu Operation

## ■ Operation Guide

### ● Power on/off

In power-off status, long press 【☺】 to enter the logo interface and it shows riding interface after 2s.



In power-on status, long press 【☺】 to power off after 2s.



● Riding menu

Your display provides various style riding interfaces, which can be shifted by clicking on **【☺】**.

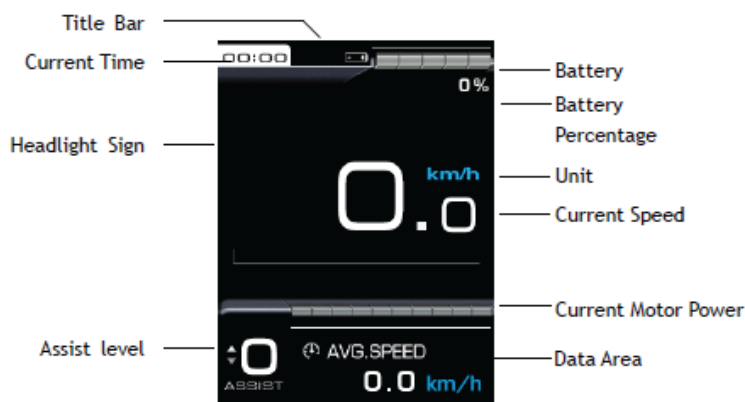

Different data display on the right below by clicking on **【☺】**:

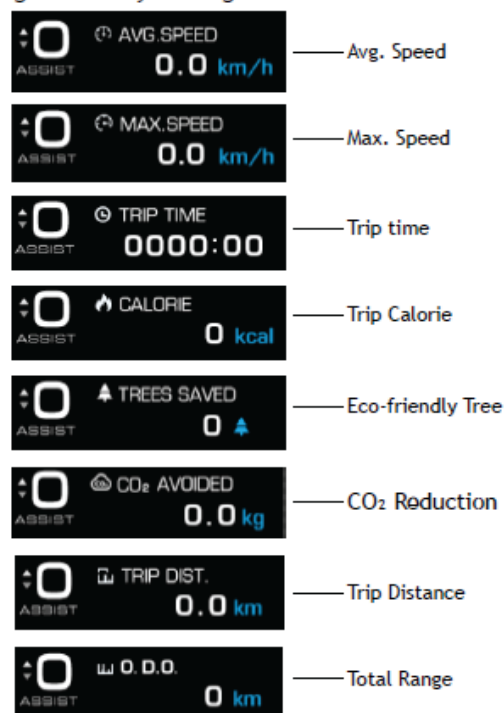

- Assist shifts

Click on **【+】** / **【-】** to shift assist level.

Long press **【-】** to start out assist mode, and release **【-】** to quit push assist mode.

- Light turns on/off

Long press **【=D】** to turn on / off headlight during riding.

- Error Display

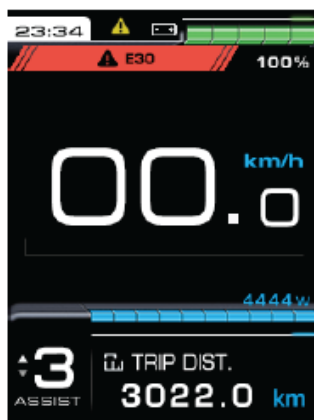

Serfas Error message:

Error Code	Error Description
E04	Throttle Hall Error
E05	Motor Phase Error
E06	Low Voltage Warning
E07	Over Voltage Protect
E08	Motor Hall Error
E09	PhaseLine Error
E10	Over Heat Protect (Motor)
E11	NTC Error (Motor)
E12	Current Sensor Error
E14	Over Heat Protect (Controller)
E15	NTC Error (Controller)
E21	Speed Sensor Error
E25	Torque Sensor Error
E26	Torque Speed Sensor Error
E27	Over Current Protect
E30	Communication Error
E31	Under Voltage Protect
E32	Over Voltage Protect
E33	Brake Error
E35	15V Power Error
E36	Key Error
E38	Watchdog Error

## ● User Menu

In a static state, long press **【i】** to enter user menu interface.

To ensure user's security, only if E-bike is static (speed is 0), it enters user menu. In this interface, click on **【☉】 / 【≡】** to switch submenu, click **【i】** to enter the selected submenu interface.

### 1、Clear Data

According to interface prompting, click on **【i】** to clear data.

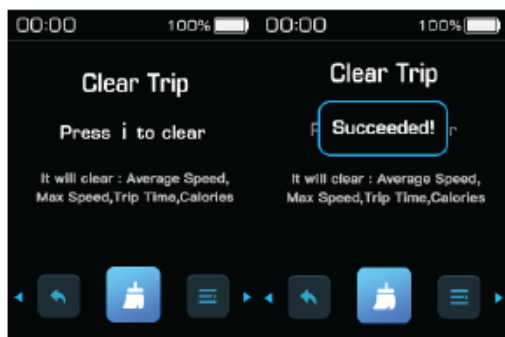

#### 【Note】

To clear Trip range, the max.speed, avg. speed, Trip total time, total calories are cleared synchronously.

### 2、Display Unit

In this interface, click on **【i】** to enter setting interface, click on **【☉】 / 【≡】** to adjust, click on **【i】** to save and exit.



### 3、Backlight Brightness

In this interface, click on **[F10]** to enter setting interface, click on **[F5]/[F11]** to adjust, click on **[F10]** to save and exit; The adjusted range is 1- 5 and Auto (Auto backlight):



### 4、Auto Power Off Time

In this interface, click on **[F10]** to enter setting interface, click on **[F5]/[F11]** to adjust, click on **[F10]** to save and exit; The adjusted range is OFF, 1-99:

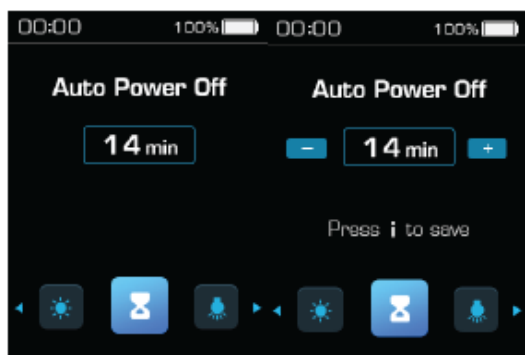

## 5、Auto Headlight

In this interface, click on **[ⓘ]** to enter setting interface, click on **[⏻]** / **[⏩]** to choose turn on headlight or not, click on **[ⓘ]** to save and exit:

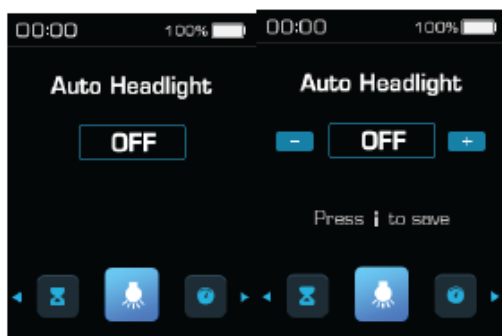

## 6、Set Time

In this interface, click on **[ⓘ]** to enter setting interface, click on **[⏻]** / **[⏩]** to adjust digits value, click on **[ⓘ]** to confirm modification.

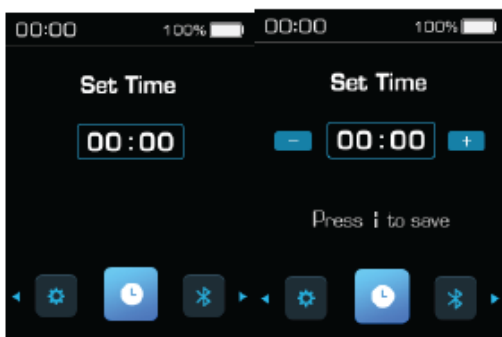

## 7、Power-on with password

In this interface, click on **[ⓘ]** to enter setting interface, click on **[+]** / **[-]** to switch selection:

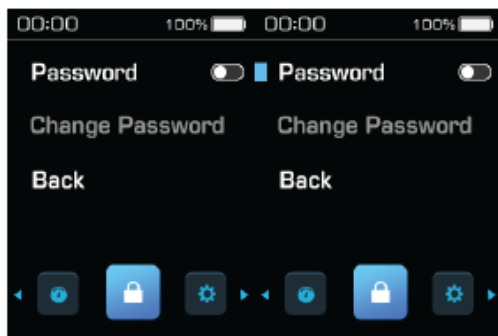

## 8、View System Info.

In System info, the system information can be viewed.

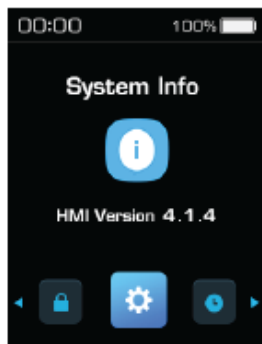

### ● Advanced Menu

In power-off status, long press **【⏻】** for 6s, it enters advanced menu login interface, click on **【+】** / **【-】** to adjust digits value, long press **【0】** to shift position or confirm login:



After login, it goes to Advanced Menu, click on **【+】** / **【-】** to adjust settings, click on **【0】** to enter submenu adjustment or adjusting directly.





## 1、Wheel Diameter

Select Diameter, click on **[0]** to enter adjustment interface, an underline appears below digits, which means to click on **[+]** / **[-]** to adjust, click on **[0]** to confirm and save.

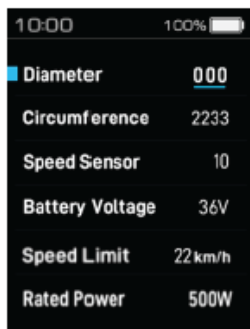

## 2、Wheel Circumference

To measure cycling range precisely, the wheel circumference setting function is provided in menu.

Selecting Circumference, click on **[0]**, it enters adjustment interface, an underline appears below digits, which means to click on **[+]** / **[-]** to adjust, click on **[0]** to confirm and save.

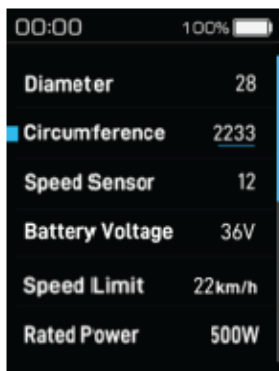

### 3、Speed Sensor

Selecting Speed Sensor, click on **【0】**, it enters adjustment interface, an underline appears below digits, which means to click on **【+】 / 【-】** to adjust, click on **【0】** to confirm and save.

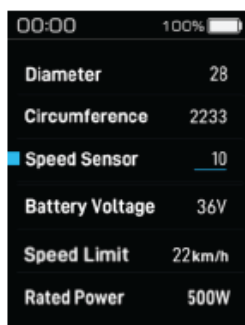

### 4、Battery Voltage

Selecting Battery Voltage, click on **【0】**, it enters adjustment interface, an underline appears below digits, which means to click on **【+】 / 【-】** to adjust, the adjusted range: 36V, 48V, 52V, click on **【0】** to confirm and save.

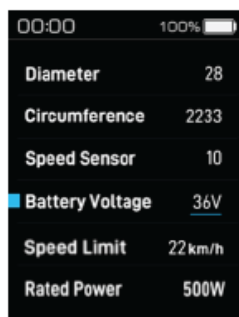

### 5、Speed Limit

Selecting Speed Limit, click on **【0】**, it enters adjustment interface, an underline appears below digits, which means to click on **【+】 / 【-】** to adjust.

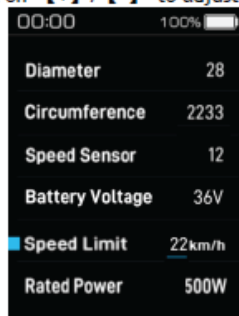

## 6、Rated Power

Selecting Rated Power, click on **[0]**, it enters adjustment interface, an underline appears below digits, which means to click on **[+]** / **[-]** to adjust.

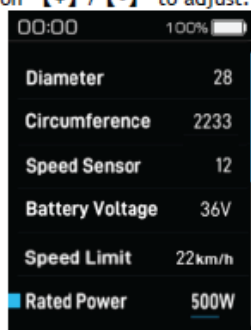

## 7、Walk Mode

Selecting Walk Mode, click on **[0]** to start/shut push assist function:

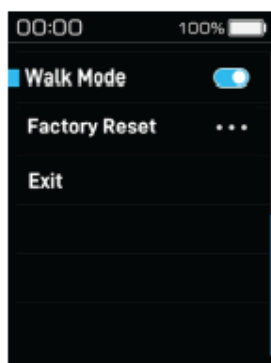

## 8、Factory Reset

Selecting Factory Reset, click on **[0]** to pop up a confirmed box, click on **[+]** / **[-]** to choose Yes, click **[0]** to reset factory.



# MAINTENANCE AND SERVICE

- When cleaning your bike, use a damp cloth and gentle dish soap. NOTE: DO NOT use a pressure washer or sprayer.
- Periodically apply a light lubricant to moving parts, including the links of the chain, derailleur pivots, and shifter cable inner wire where it enters the cable housing.
- If you ride in wet / humid environments, clean and dry electric connections and apply an anti-corrosive.

All bicycles will need a periodic tune-up or adjustments by a professional. An annual "check-up" is beneficial. Your bike's service schedule will depend on the frequency of its use. In-between expert services at a bike shop we suggest:

- Keep tires inflated to their recommend pressure (30-50 PSI / 2.0-3.5 BAR / 200-350 KPA) and check weekly.
- Clean the drivetrain and lubricate the chain (monthly).

## STORING YOUR BIKE

From time to time, you may wish to store your bike for an extended period without riding. Proper storage can help prolong the life of your e-bike components and battery.

To ready your bike for storage, first fully charge the battery. Then remove the battery from the bike and store it separately. Removing the battery from the bike puts it into a low-voltage state designed for long term storage.

Keep both the bike and the battery in a cool, dry place. Avoid both very hot and very cold temperatures. Generally if the environment is comfortable for humans, then it's a good place to store your bike.

Store your bike away from sources of heat, UV light, and ozone - all of which can prematurely age rubber tires and tubes.

All bicycle tubes slowly lose air over time and need to be regularly topped off to maintain proper pressure. This does not mean that your bicycle has a flat tire. Avoid allowing the tires to deflate completely during storage.

## LIMITED LIFETIME WARRANTY

The specific warranty covering your Serfas bicycle is governed by the law of the state or country in which it was purchased, and applies only to bicycles purchased from Authorized Serfas Retailers.

### FRAMES AND FORKS:

Serfas frames made from steel or aluminum (Dash e-bikes) are warranted by Serfas Bikes, 2333 W. Utopia Rd., Phoenix, AZ 85027 against manufacturing defects in materials and/or workmanship for 2 years to the original owner.

### COMPONENTS:

All other components, frame fixtures, and finishes (paint and decals) are warranted against manufacturing defects in materials and/or workmanship for a period of one year from the date of original retail purchase. Forks (other than those made by Serfas - for example, a Rockshox suspension fork) are not covered by this limited warranty, but are separately covered by the stated warranty of their manufacturer. Stripped threads due to user error are not covered by this warranty.

To qualify for warranty coverage, bike must be registered within 1 month of purchase at below address.

Register at: [www.serfas.com/warranty-form](http://www.serfas.com/warranty-form)



SERFAS®

[www.serfas.com](http://www.serfas.com)